

DTS KAI  
AQUASAFE:  
U-TYPE

SUBJECT DESCRIPTION:  
**DTS KAI 51 MM BI DEUR**

PRODUCT NAME:  
**KAI**



Product tolerances according to ISO 2768-m



VERSION NUMBER:  
**1.01**

PAGE:  
**1 / 7**

FORMAT:  
**A4**

shared solutions

DRAWING:  
**K\_KAI-1**

SCALE:  
**N/A**

DRAWN BY:  
**BE**

Aalsvoort 5, 7241 MA LOCHEM  
+31 (0) 573 - 438 428

INNODEEN.NL

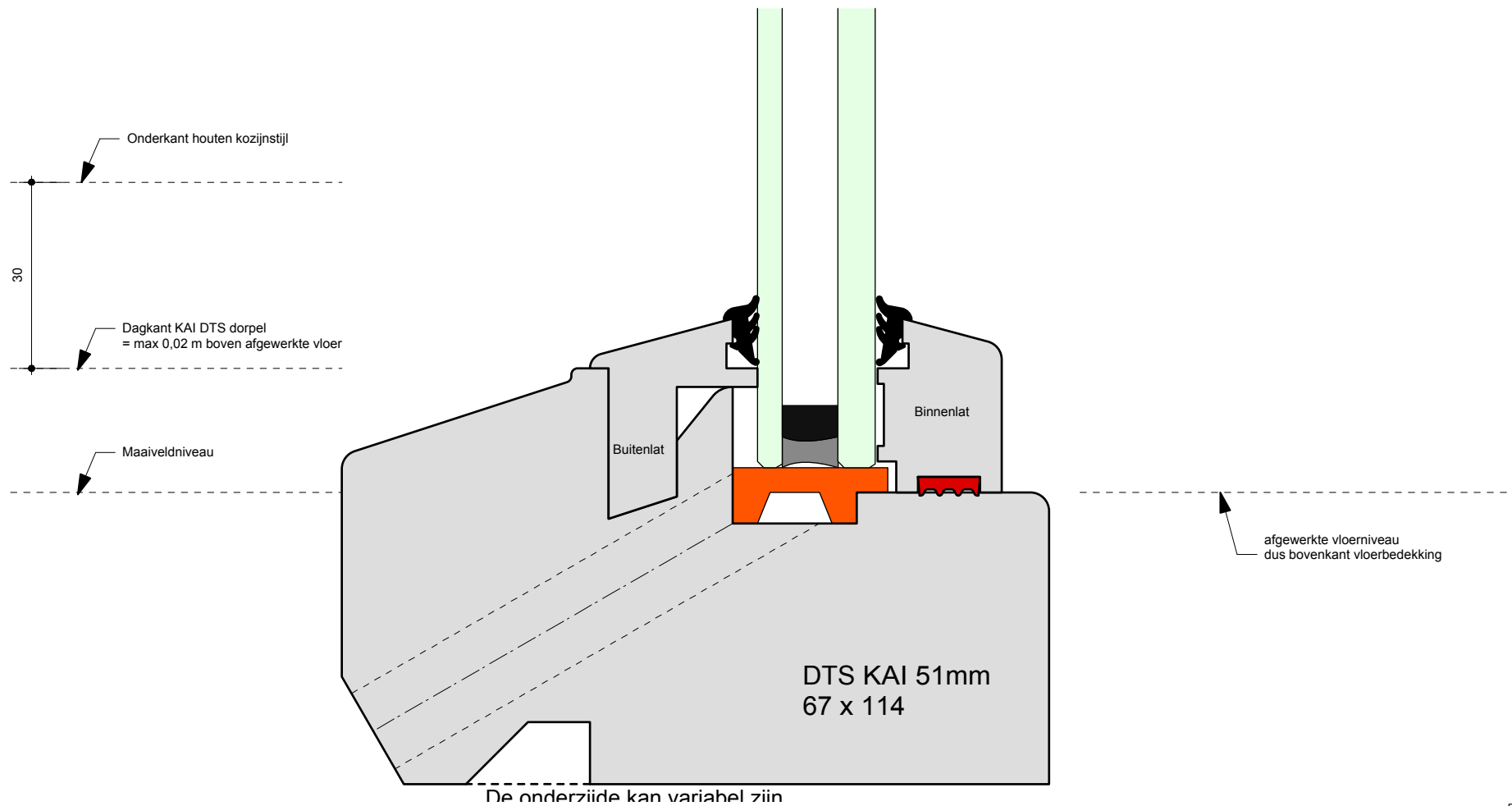

DTS KAI  
AQUASAFE:  
U-TYPE

SUBJECT DESCRIPTION:  
**DTS KAI 51 MM BI GLASVAK** (niet gestest)

PRODUCT NAME:  
**KAI**



Product tolerances according to ISO 2768-m



VERSION NUMBER:  
**1.01**

PAGE:  
**2 / 7**

FORMAT:  
**A4**

shared solutions

DRAWING:  
**K\_KAI-2**

SCALE:  
**N/A**

DRAWN BY:  
**BE**

Aalsvoort 5, 7241 MA LOCHEM  
+31 (0) 573 - 438 428

INNODEEN.NL

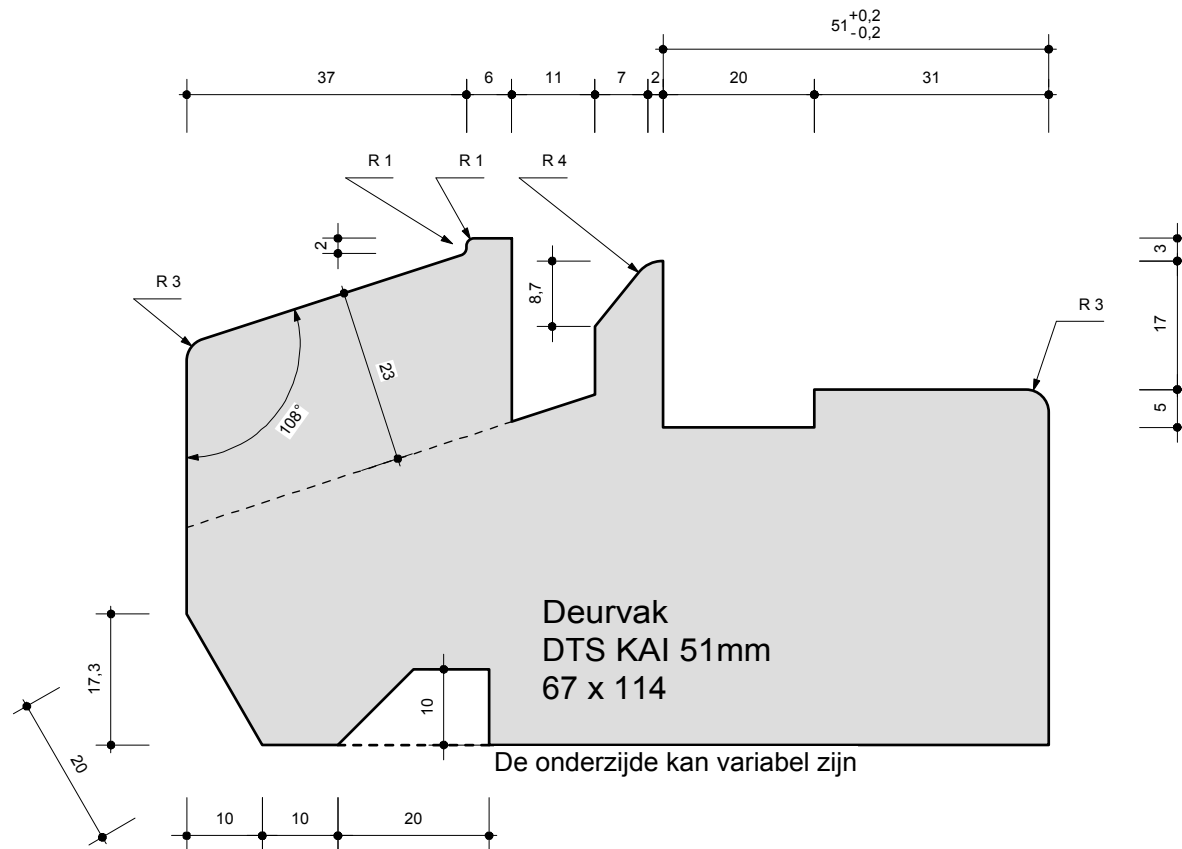

DTS KAI  
AQUASAFE:  
U-TYPE

SUBJECT DESCRIPTION:  
**DTS KAI 51 MM - INKROOSSLEUVEN DEURVAK**

PRODUCT NAME:  
**KAI**



Product tolerances according to ISO 2768-m



VERSION NUMBER:  
**1.01**

PAGE:  
**3 / 7**

FORMAT:  
**A4**

shared solutions

DRAWING:  
**K\_KAI-3**

SCALE:  
**N/A**

DRAWN BY:  
**BE**

Aalsvoort 5, 7241 MA LOCHEM  
+31 (0) 573 - 438 428

INNODEEN.NL

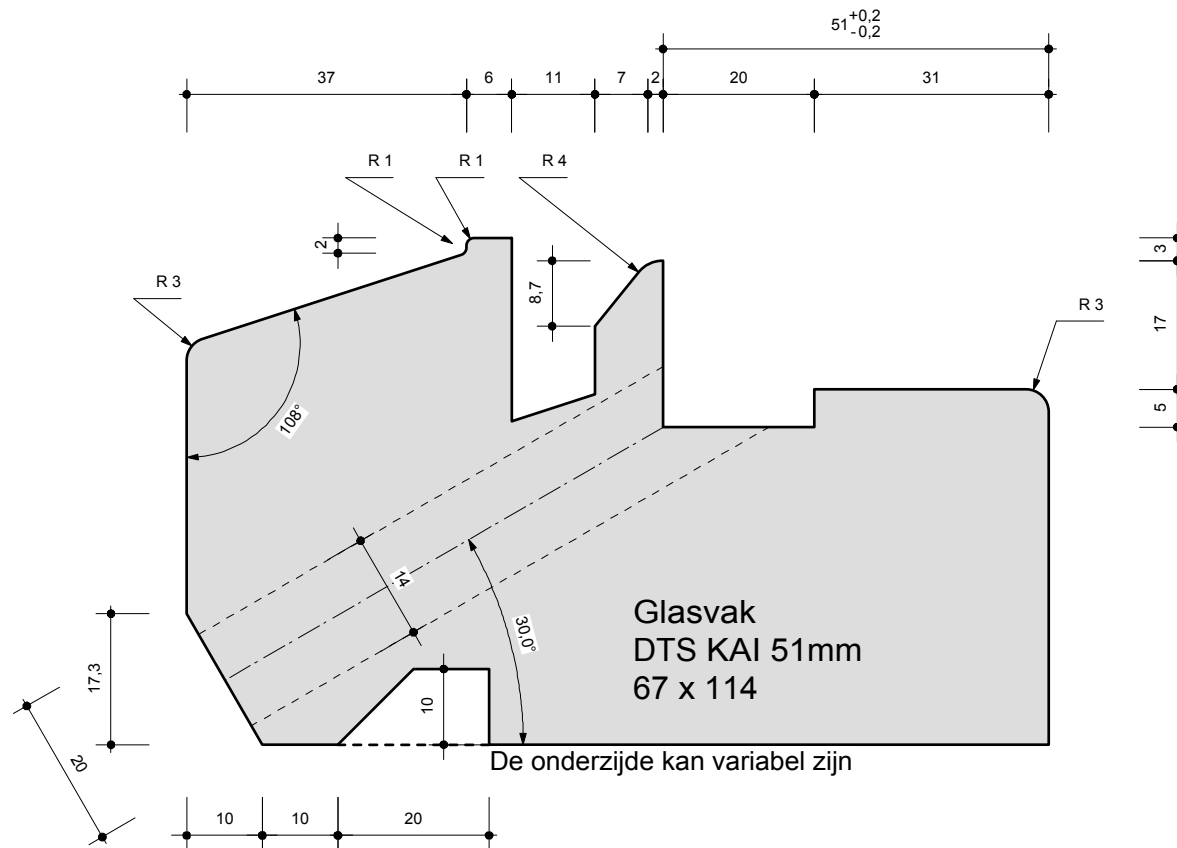

Glasvak  
DTS KAI 51mm  
67 x 114

De onderzijde kan variabel zijn

DTS KAI  
AQUASAFE:  
U-TYPE

SUBJECT DESCRIPTION:  
**DTS KAI 51 MM - MAATVOERING AFWATERING TPV GLAS**

PRODUCT NAME:  
**KAI**



Product tolerances according to ISO 2768-m



VERSION NUMBER:  
**1.01**

PAGE:  
**4 / 7**

FORMAT:  
**A4**

shared solutions

DRAWING:  
**K\_KAI-4**

SCALE:  
**N/A**

DRAWN BY:  
**BE**

Aalsvoort 5, 7241 MA LOCHEM  
+31 (0) 573 - 438 428

INNODEEN.NL

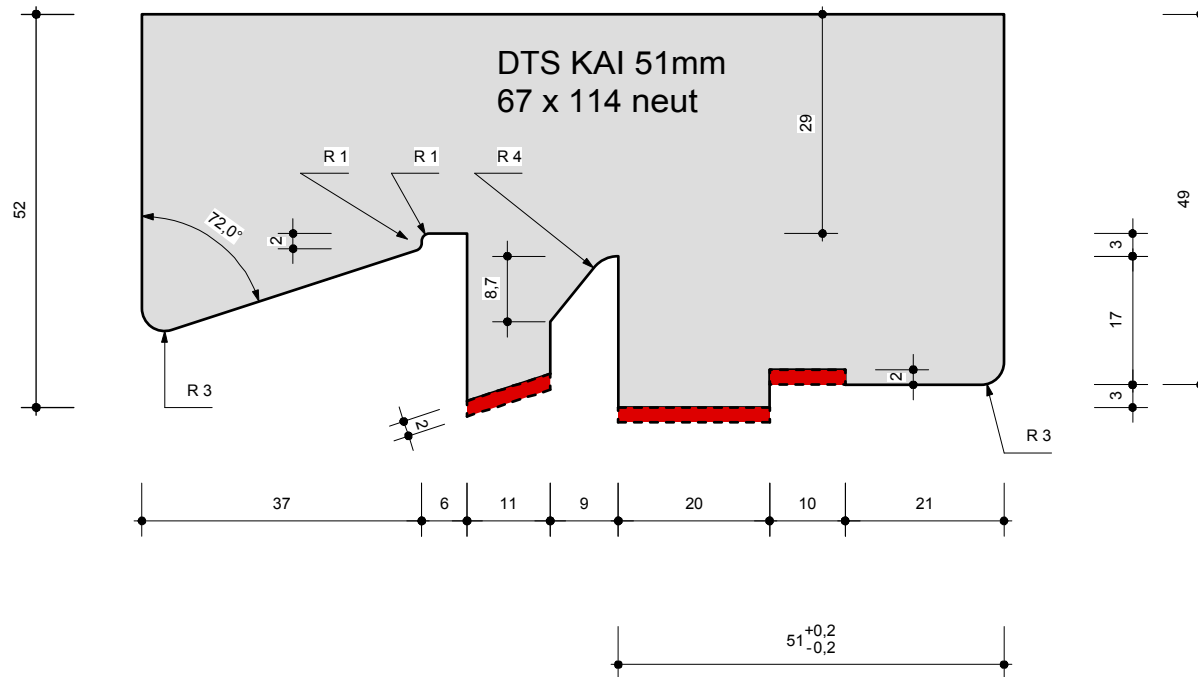

DTS KAI  
AQUASAFE:  
U-TYPE

SUBJECT DESCRIPTION:  
**DTS KAI 51 MM - MAATVOERING NEUT**

PRODUCT NAME:  
**KAI**



Product tolerances according to ISO 2768-m



VERSION NUMBER:  
**1.01**

PAGE:  
**5 / 7**

FORMAT:  
**A4**

shared solutions

DRAWING:  
**K\_KAI-5**

SCALE:  
**N/A**

DRAWN BY:  
**BE**

Aalsvoort 5, 7241 MA LOCHEM  
+31 (0) 573 - 438 428

INNODEEN.NL



DEVENTER SV 2 droog beglazings-  
 profiel met inbouwmaat 4mm  
 ZWART

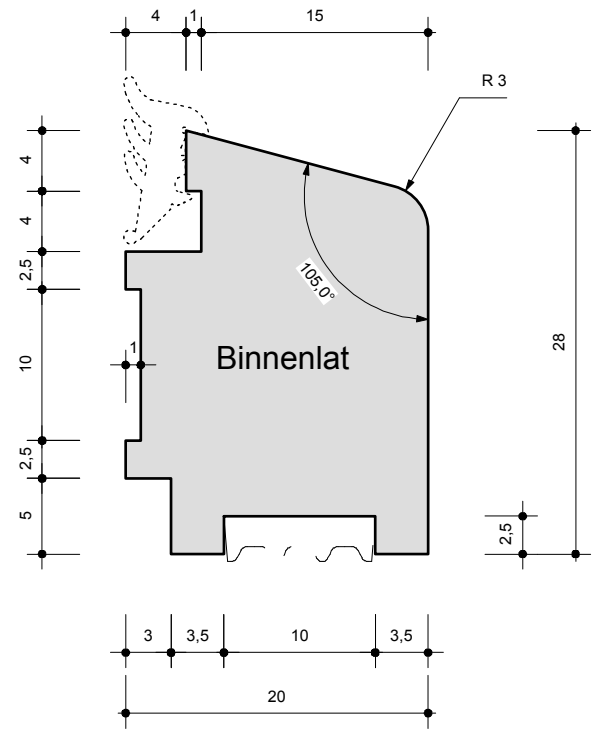
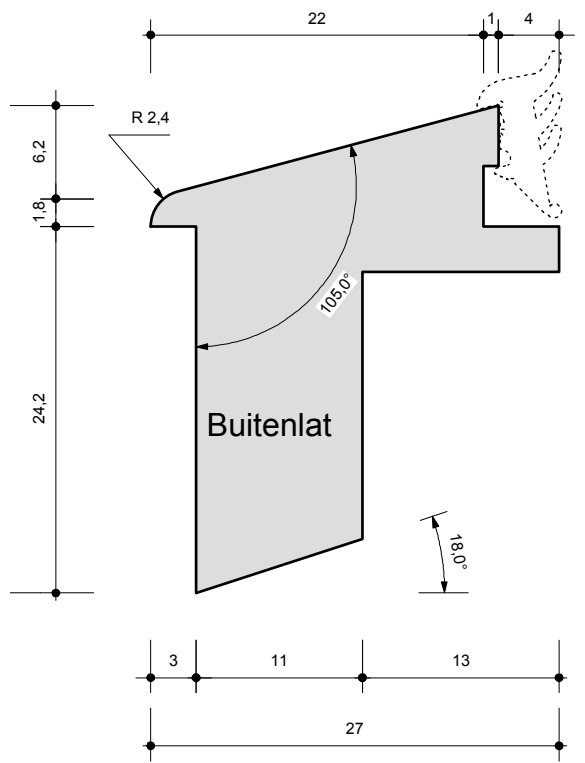

DTS KAI  
 AQUASAFE:  
 U-TYPE

SUBJECT DESCRIPTION:  
**DTS KAI 51 MM - BEGLAZINGSLATTEN**

PRODUCT NAME:  
**KAI**



Product tolerances according to ISO 2768-m



VERSION NUMBER:  
**1.01**

PAGE:  
**6 / 7**

FORMAT:  
**A4**

shared solutions

DRAWING:  
**K\_KAI-6**

SCALE:  
**N/A**

DRAWN BY:  
**BE**

Aalsvoort 5, 7241 MA LOCHEM  
 +31 (0) 573 - 438 428

INNODÉEN.NL

# Principe aanzichten KAI systeem met een deurvak en glasvak inkrozingen en boorgaten

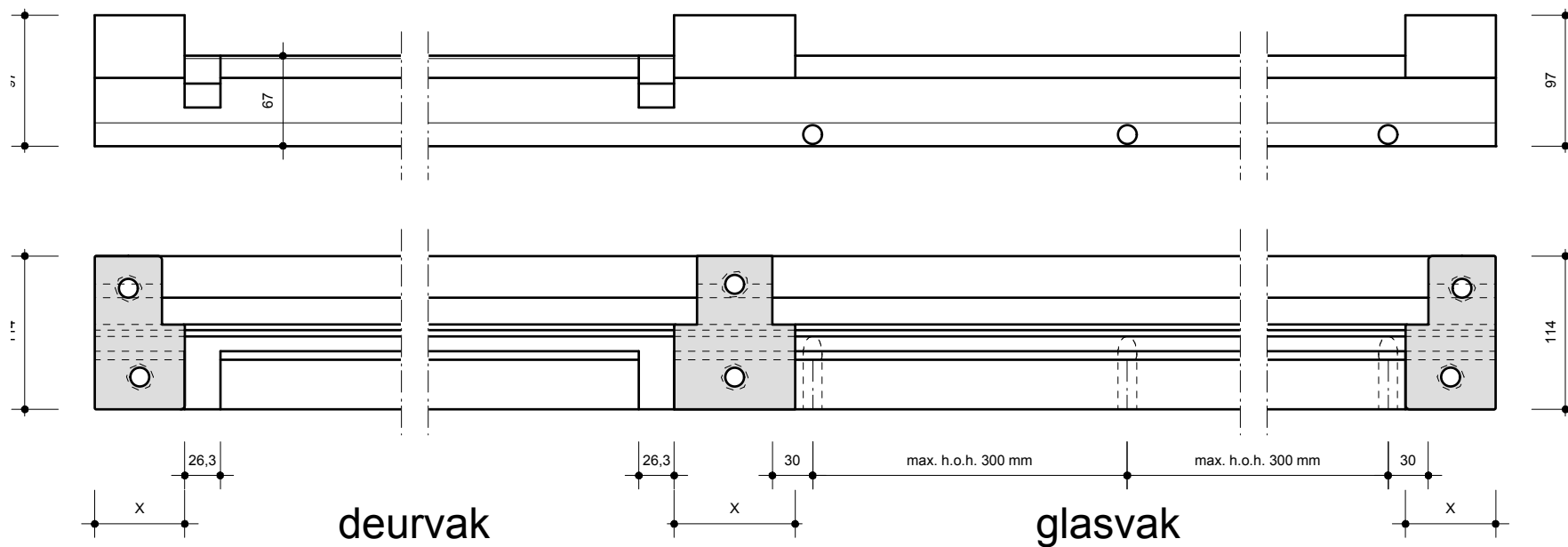

DTS KAI  
AQUASAFE:  
U-TYPE

SUBJECT DESCRIPTION:  
**DTS KAI 51 MM PRINCIPE AANZICHT**

PRODUCT NAME:  
**KAI**



Product tolerances according to ISO 2768-m



VERSION NUMBER:  
**1.01**

PAGE:  
**7 / 7**

FORMAT:  
**A4**

shared solutions

DRAWING:  
**K\_KAI-7**

SCALE:  
**N/A**

DRAWN BY:  
**BE**

Aalsvoort 5, 7241 MA LOCHEM  
+31 (0) 573 - 438 428

INNODEEN.NL